

PS/PJ/PG-Type

Pneumatic Hammers & Blasters

Pneumatikklopper & Luftstoss austraghilfen

Systèmes de dévôtage à percussion

Sistemi di discesa a percussione



PS-Type



The Electro Pneumatic Hammer MARTSHOCK produces a violent impact on the walls to which it is installed. The energy released in the instant of the collision is great enough to solve all problems arising in the extraction of products stocked in bins of any shape and dimension. Guaranteed life at maximum pressure: 150,000 blows. Working temperature: -20°C to + 80°C.

Der MARTSHOCK Electro Pneumatikklopper bringt filiebrträge Schüttgüter durch intervallgesteuerte, wuchtige Schläge gegen den Behälterkonus wieder in Bewegung. Die im Moment der Schlägeinwirkung freigesetzte Energie überträgt sich auf das eingelagerte Schüttgut und bewirkt einen problemfreien Austrag sowie nahtlosen Übergang in weiterführende Prozesse. Garantierte Lebensdauer bei maximalem Druck = 150.000 Schläge. Betriebstemperatur: -20°C bis + 80°C.

Le perceur electro pneumatique MARTSHOCK produit un choc très violent sur les parois où il est installé. L'énergie libérée au moment de l'impact est telle qu'elle permet de résoudre immédiatement les problèmes d'écoulement de produits stockés en réservoirs de toute forme et dimension. La durée est garantie jusqu'à 150.000 coups à la pression maximum. Température d'exercice: -20°C à + 80°C.

Il percussore electro pneumatico MARTSHOCK determina un'azione d'urto violentissima alle pareti sulle quali viene installato. L'energia liberata nell'attimo dell'impatto è di entità tale da consentire l'immediata risoluzione di qualsiasi situazione di crisi nella discesa di prodotti stoccati in contenitori di ogni forma e dimensione. La durata è garantita fino a 150.000 colpi alla massima pressione. Temperatura di esercizio: -20°C + 80°C.

Pneumatic Hammers

Pneumatikklopper
Percuteurs pneumatiques
Percussori pneumatici

MARTSHOCK



PJ-Type



The PICJET® combined hammer blast is electropneumatically actuated, and it develops three simultaneous actions: 1) instantaneous hammering 2) extended vibration 3) extended and intermittent airshot along the silo wall. The combined effect of these three actions resolves globally and radically all mass flow problems. Guaranteed life at maximum pressure: 150,000 blows. Working temperature: -20°C to + 80°C.

Der Kombi - Klopper PICJET®, der in elektropneumatischer Version lieferbar ist, erfüllt gleichzeitig drei verschiedene Funktionen: 1) Klopfen 2) Nachrütteln 3) Luftstoß entlang der Behälterwand kontinuierlich oder in Intervallen. Der Kombi-Klopper löst durch die kombinierte Funktion jedes Austragproblem radikal und gründlich. Garantierte Lebensdauer bei maximalem Druck = 150.000 Schläge. Betriebstemperatur: -20°C bis + 80°C.

Combined hammer blasts

Kombi-klopper
Percuteurs combinés
Percussori combinati

PICJET®



Le perceur combiné PICJET®, électropneumatique développe 3 actions simultanément: 1) Percussion instantanée 2) Vibration prolongée 3) Jet d'air latéral en action prolongée et intermittente. L'effet combiné des 3 forces simultanées permet de résoudre globalement et radicalement chaque problème d'écoulement de produit. La durée est garantie jusqu'à 150.000 coups à la pression maximum. Température d'exercice: -20°C à + 80°C.

Il percussore combinato PICJET®, elettropneumatico, sviluppa tre azioni simultanee: 1) Percussione istantanea 2) Vibrazione prolungata 3) Getto di aria lungo le pareti in azione prolungata e intermittente. L'effetto combinato delle tre azioni simultanee permette di risolvere in modo globale e radicale ogni problema di discesa dei materiali. La durata è garantita fino a 150.000 colpi alla massima pressione. Temperatura di esercizio: -20°C + 80°C.

PG-Type



The GUNJET-type Air Cannon, which is activated electropneumatically, releases almost instantaneously a certain quantity of highly compressed air inside the silo or bin, thus provoking the typical effect of an explosion. GUNJET Air Cannons are particularly suitable for use with materials with a strong tendency to rat-holing. The GUNJET-type Air Cannon can be equipped with a control panel for adjustment of the air jet and the operation intervals.

Die elektropneumatisch betriebenen Luftkanonen vom Typ GUNJET geben explosionsartig einen Druckluftstoß gegen die Innenwände von Behältern ab, die mit schwer fließenden Schüttgütern befüllt sind. GUNJET Luftkanonen sind besonders geeignet zum Einsatz mit Schüttgütern, die zu starker Schlotbildung neigen. Zur Regelung des Luftstoßes können GUNJET Luftkanonen mit einer Steuerung zur Einstellung der Luftstoßdauer und Betriebsintervalle ausgestattet werden.

Le canon à air GUNJET, qui peut être actionné électropneumatiquement envoie presque instantanément une quantité d'air à haute pression provoquant les effets typiques d'une explosion. Le canon à air GUNJET est particulièrement indiqué à l'utilisation avec des matériaux avec une tendance forte à la formation de trous de souris. Le canon à air GUNJET peut être équipé avec un tableau de commande pour le réglage du temps de pause et de travail.

Il percussore GUNJET, elettropneumatico, invia quasi istantaneamente all'interno del recipiente una quantità d'aria ad alta pressione provocando gli effetti tipici di una esplosione. Il percussore GUNJET è particolarmente adatto all'uso con materiali con una forte tendenza alla formazione di fori di topo. Il percussore GUNJET può essere dotato di un quadro di comando per la regolazione del tempo di pausa e di lavoro.

Air Cannons

Luftkanonen
Canons d'air
Cannoni ad aria

GUNJET

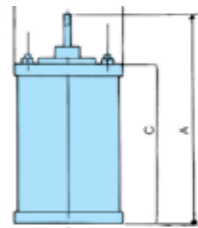
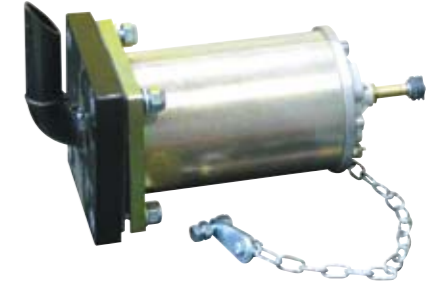

Weld-on base plate
Aufschweißplatte
Support à souder
Piastra a saldare

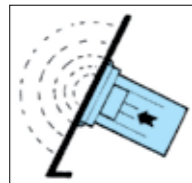

PS.....B
For bins with steel plate thickness > 3mm
Für Trichter mit Blechstärke > 3mm
Pour trémies avec épaisseur > 3 mm (pour modèles 063 et 080)
Versione per tramogge con lamiera di spessore > 3 mm

PS.....A
For bins with steel plate thickness < 3 mm (only for size 063 and 080)
Für Trichter mit Blechstärke < 3 mm (für die Modelle 063 und 080)
Pour trémies avec épaisseur < 3 mm (pour modèles 063 et 080)
Versione per tramogge con lamiera di spessore < 3 mm (per i soli modelli 063 e 080)

TYPE	A	ØB	C	ØE	F	G	ØH	Air consumption NI per cycle Luftverbrauch NI pro Zyklus Consomm. d'air NI par cycle Consumo d'aria NI per ciclo		Air connection Luftanschluß Raccord d'air Attacco d'aria	Energy				kg	Packing Verpackung Emballage Imballo
								3 bar	6 bar		3 bar	6 bar	J	kpm		
PS032	188	105	136	130	15	48	160	2.52	4.41	1/8 pipe 8 mm	4.2	0.42	7.1	0.72	6.5	270x185x170
PS040	245	115	175	130	20	60	160	3.60	6.30	1/8 pipe 8 mm	8.4	0.86	18.1	1.85	8.5	270x185x170
PS063	281	150	213	160	20	75	220	6.40	11.20	1/4 pipe 8 mm	28.8	2.94	62	6.34	16.5	450x200x220
PS080	340	200	266	200	25	94	250	12.52	21.90	1/4 pipe 8 mm	59.2	6.0	153	15.6	30	450x200x220

Dimension in mm

SILO WALL
SILOWAND
PAROI SILO
PARETE SILO

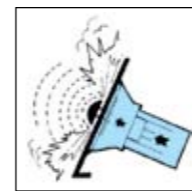
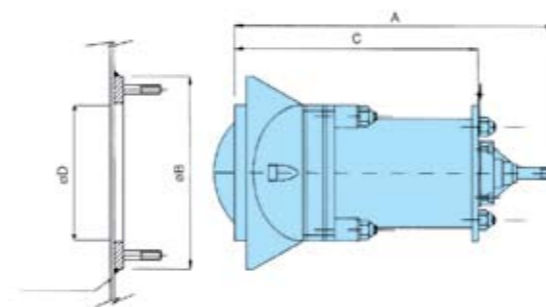

TYPE	A	ØB	C	ØD	Air consumption NI per cycle Luftverbrauch NI pro Zyklus Consomm. d'air NI par cycle Consumo d'aria NI per ciclo		Air connection Luftanschluß Raccord d'air Attacco d'aria	Energy				kg	Packing Verpackung Emballage Imballo
					3 bar	6 bar		3 bar	6 bar	J	kpm		
PJO32	285	170	210	121	2.52	4.41	1/8 pipe 6 mm	4.2	0.42	7.1	0.72	7.9	450x200x220
PJO40	330	170	255	121	3.60	6.30	1/8 pipe 6 mm	8.4	0.86	18.1	1.85	10	450x200x220
PJO63	385	222	310	155	6.40	11.20	1/4 pipe 8 mm	28.8	2.94	62	6.34	19.3	450x200x220
PJO80	465	280	390	176	12.52	21.90	1/4 pipe 8 mm	59.2	6.0	153	15.6	40	450x200x220

Dimension in mm

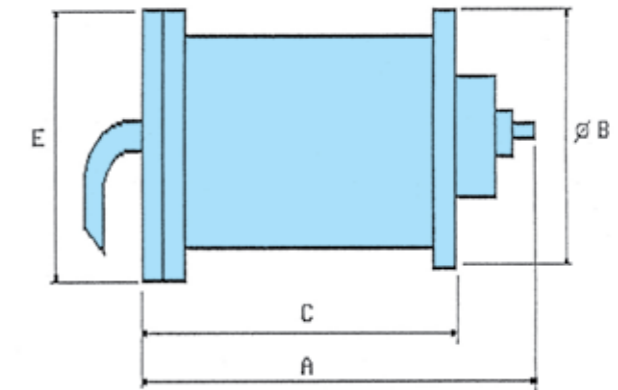

TYPE	A	ØB	C	ØE	Air consumption NI per cycle Luftverbrauch NI pro Zyklus Consomm. d'air NI par cycle Consumo d'aria NI per ciclo		Air connection Luftanschluß Raccord d'air Attacco d'aria	kg	Packing Verpackung Emballage Imballo
					3 bar	6 bar			
PG032	205	105	135	120	2.52	4.41	1/8 pipe 8 mm	6.2	270x185x170
PG040	245	115	175	120	3.60	6.30	1/8 pipe 8 mm	8.2	270x185x170
PG063	285	150	215	150	6.40	11.20	1/4 pipe 8 mm	16.2	450x200x220
PG080	335	200	265	200	12.52	21.90	1/4 pipe 8 mm	29.7	450x200x220

Dimensions in mm



STANDARD APPLICATION

STANDARDEINBAU

APPLICATION STANDARD

APPLICAZIONE STANDARD

PS-PJ

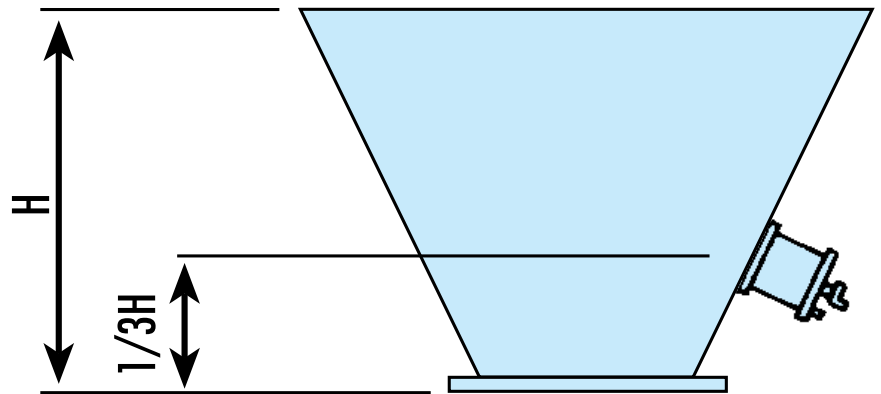

PG

